

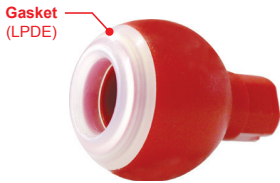

HGQ 2195 D5G
Flat fan nozzle

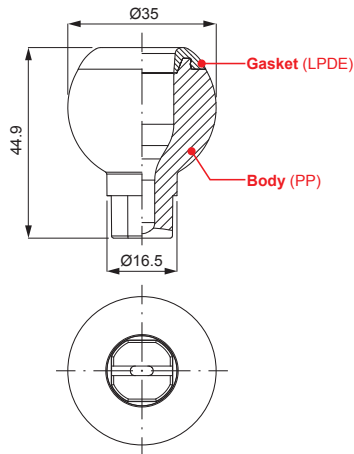

Gasket (LPDE)

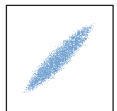
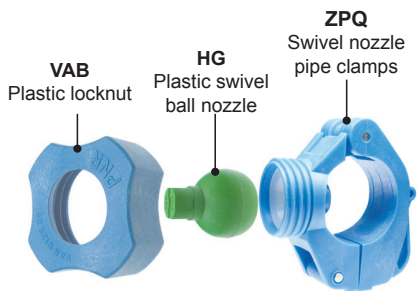

Spray section

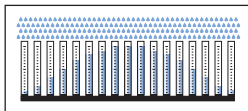

Convex distribution



PLASTIC SWIVEL BALL NOZZLES

HGQ and RGN plastic swivel ball nozzles are designed for diversified applications. They allow an easy adjustment of their spray jet direction and offer a quick-fit connection.

- Nozzle type Flat fan nozzles
Hollow cone nozzles
- Typical application Cleaning equipment used in pre-treatment for coating process
- Material Body **D5** Powder-filled polypropylene

FLAT FAN NOZZLES

HGQ flat fan nozzles feature a 60° spray angle and their wide range of flow rates makes them the best choice in pre-treatment plants. For an easier identification and use, they are made in different colours depending on the flow rate. The material is top quality PP, chemically bonded fibreglass to offer the best stability at high temperatures and resistance to chemicals.

Code	Capacity at different pressure values (l/min) (bar)					Color	W g	
60°	HGQ 1390 D5G	1.7	2.0	2.4	2.9	3.3	Black	16
	HGQ 1770 D5G	3.2	3.8	4.5	5.5	6.4	Purple	
	HGQ 1980 D5G	4.0	4.7	5.6	6.9	8.0	Brown	
	HGQ 2117 D5G	4.6	5.5	6.5	8.0	9.3	Yellow	
	HGQ 2135 D5G	5.5	6.5	7.8	9.5	11.0	Gray	
	HGQ 2155 D5G	6.2	7.4	8.8	10.8	12.5	Red	
	HGQ 2195 D5G	7.8	9.2	11.0	13.8	15.6	Green	
	HGQ 2230 D5G	9.5	11.3	13.5	16.3	19.1	Blue	
	HGQ 2270 D5G	10.9	12.8	15.4	18.8	21.7	Sky blue	
	HGQ 2337 D5G	13.8	16.4	19.5	24.0	27.7	White	
	HGQ 2410 D5G	16.7	19.8	23.6	29.0	33.5	Pink	
Pressure (bar)		0,5	0,7	1,0	1,5	2,0		

HOLLOW CONE NOZZLES

RGN hollow cone nozzles have a 50° spray angle and offer a wide range of flow rates, all identified by a particular nozzle colour to avoid any possible confusion. The material is top quality PP, chemically bonded fibreglass to offer the best stability at high temperatures and resistance to chemicals. For these features they are widely used in pre-treatment plants.

Code	Capacity at different pressure values (l/min) (bar)					Color	W g	
50°	RGN 2175 D5G	7.1	8.5	10.1	12.4	14.3	Red	25
	RGN 2215 D5G	8.8	10.4	12.4	15.2	17.6	Blue	
	RGN 2390 D5G	15.9	18.8	22.5	27.6	31.8	Black	
Pressure (bar)		0,5	0,7	1,0	1,5	2,0		

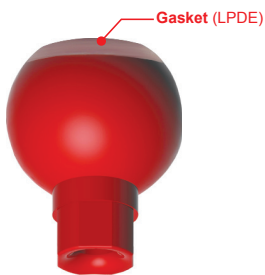

RGN
Hollow cone nozzle

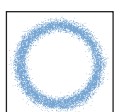
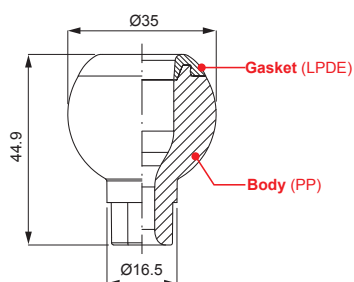

Spray section

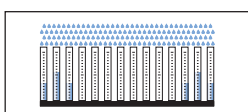

Concave distribution

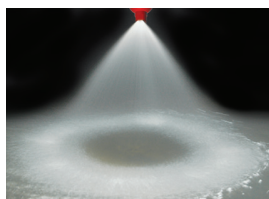

HOW TO MAKE UP THE NOZZLE CODE

EX.: HGQ 1390 D5G

HGQ **1390** **D5G**

MATERIAL • D5 - Powder-filled polypropylene

CAPACITY

NOZZLE TYPE • HGQ - Flat fan nozzles (60°)

• RGN - Hollow cone nozzles (50°)